

- <sup>ぶんどき</sup>分度器の中心を点アに合わせて次の角度をかきましょう。

1 195°

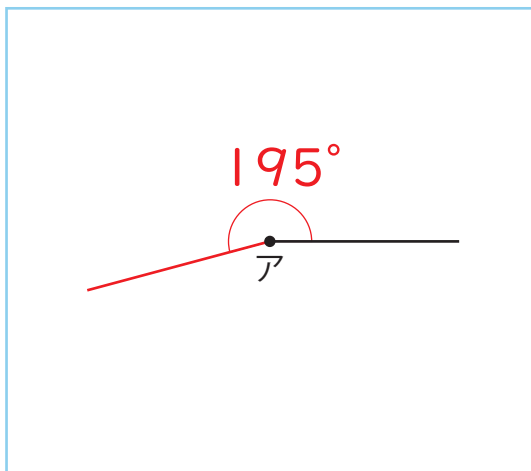

2 325°

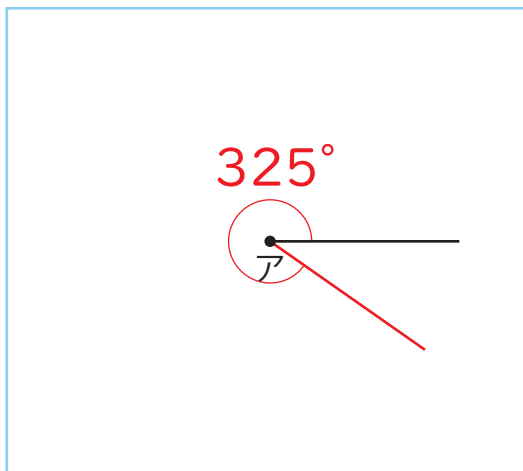

3 320°

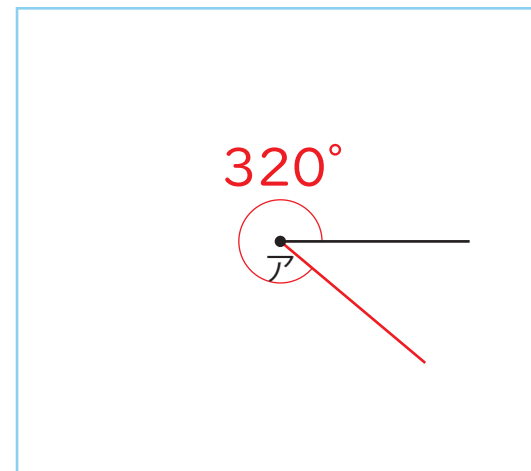

4 345°

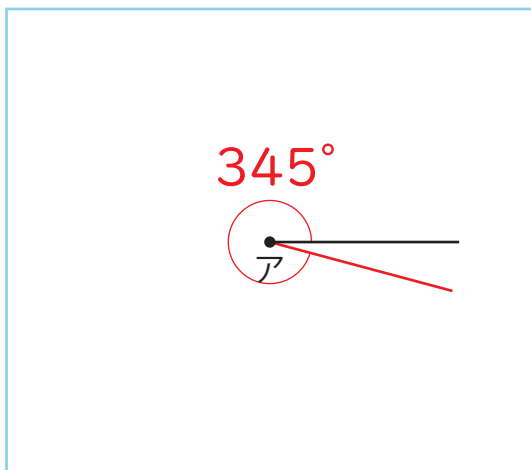

5 220°

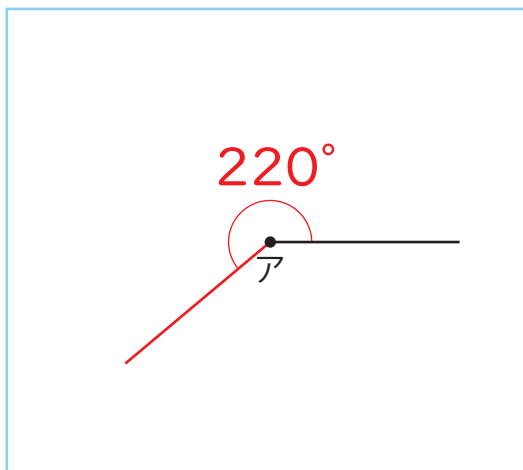

6 235°

